

-1-PB-Model\_test\_of\_pull-  
upCapacity...\_cohesive\_soil-  
ASLI.pdf  
*by*

---

**Submission date:** 08-Dec-2022 10:19AM (UTC+0700)

**Submission ID:** 1974896058

**File name:** -1-PB-Model\_test\_of\_pull-upCapacity...\_cohesive\_soil-ASLI.pdf (1.99M)

**Word count:** 5641

**Character count:** 27401



## Model Test of the Pull-up Capacity of Folding Type Ground Anchors in Cohesive Soil

Muhammad I. Maming<sup>1\*</sup>, A. R. Djamaluddin<sup>1</sup>, Tri Harianto<sup>1</sup>,  
Achmad B. Muhiddin<sup>1</sup>

<sup>9</sup>  
*Civil Engineering Department, Faculty of Engineering, Hasanuddin University, Makassar, Indonesia.*

Received 14 June 2022; Revised 06 August 2022; Accepted 17 August 2022; Published 01 September 2022

### Abstract

The purpose of this research is to develop a folding anchor model, which is a modification of the star-shaped plate anchor, and to investigate the pull-up capability operating in cohesive soils. Physical testing is performed in the laboratory and on a full scale in the field, with the findings of the pull-up capacity achieved compared. The anchor model is made up of four leaves with varying widths and depths. It is flexible and may be closed and opened like an inverted umbrella. The effective area of each anchor was determined in laboratory experiments to be A1=30.00, A2=57.60, and A3=147.20 cm<sup>2</sup>, evaluated in a test column b<sup>20</sup> and filled with statically compressed, cohesive soil in four layers to a height of 30 cm. Each model was evaluated at three different depths: 30, 60, and 90 cm. The effective area of each anchor in field testing is B1=57.60, B2=147.20, and B3=600 cm<sup>2</sup>. The qualities of the soils chosen in the laboratory and in the field are identical. Each model was tested at three different depths: 100, 200, and 300 cm. The most resemblance to pull-up test results was found in laboratory and outdoor testing. The findings indicated that the area of each anchor model increased at each depth, resulting in a considerable rise in pull-up load. The change in depth of each anchor variation, however, did not result in a substantial increase in pull-up load. This implies that the folding type model anchors do not need extensive design. Each area change has a fundamental constraint in that adding depth will no longer result in a higher maximum pull-up capability. It also shows that these anchors are relatively simple to install in the field using basic tools without excavating or drilling the soil.

*Keywords:* Pull-Up Capacity; Ground Anchors; Four Elements; Folding Type; Cohesive Soil.

### 1. Introduction

Indonesia has around 3,700 inhabited islands and a coastline of 80,000 kilometres stretching from Sabang to Merauke. Residents in Indonesia often utilise coastal maritime regions to conduct different activities to suit their requirements, such as industrial areas, ports, fishing operations, agricultural, government, and tourist areas, so various infrastructure and facilities must be created offshore and along the coast. Many soft soil deposits may be found in coastal regions, offshore waterways, and on land in numerous coastal places across Indonesia's islands [1]. One of the engineering geological restrictions that might pose issues in infrastructure development and spatial planning is soft soil. Because of their limited bearing capacity, soft soils often pose issues in building, and settlements are possible [2]. The fundamental issue that coastal or offshore structures confront is structural stability owing to seawater movement, both vertically due to tides and horizontally due to currents, wind, and waves. To maintain stability owing to vertical uplift, a retaining structure known as an anchor is required [3]. Soil anchor structures have been created for a variety of applications, including slope reinforcement, retaining walls (pipe), tunnel stability, transmission tower foundations to bear tensile pressures, overturning, and so on [4].

<sup>1</sup>  
\* Corresponding author: [mamingmi17d@student.unhas.ac.id](mailto:mamingmi17d@student.unhas.ac.id)

<http://dx.doi.org/10.28991/CEJ-2022-08-09-07>



© 2022 by the authors. Licensee C.E.J, Tehran, Iran. This article is an open access article distributed under the terms and conditions of the Creative Commons Attribution (CC-BY) license (<http://creativecommons.org/licenses/by/4.0/>).

There are several kinds of anchors that have been designed for diverse applications based on the magnitude and type of load, construction type, local soil conditions, and so on. There has already been research on the usage of anchors. Several scholars have already conducted research on the pull-out capability of the ground anchor. Other research findings aim to better understand the behaviour of anchors in soft soils under static and cyclic dynamic stresses [5]. Further research advances in the creation of anchor designs and models with simplicity of installation and high bearing capacity are required [6]. The usage of folding type anchors on cohesive soils is done with the presumption that the anchor components will blossom at the time of withdrawal up to the maximum pull-up limit [1]. Based on the reasons stated above, this study will develop a folding anchor model as well as test the performance of the anchor to be produced, particularly in terms of pull-up capability for many depth variations inserted into the cohesive soil [7].

## 2. Literature Review

Ground anchoring is also known as alluvian anchoring, ground anchoring, or tieback anchoring. Drilling is performed in soil composed of a layer of sand, a layer of gravel, a layer of cohesive fine-grained soil, or weathered rock, where a portion resists tensile strain in the form of cement with steel cables or cement with steel rods and plates with steel rods put into the soil [8, 9]. The drilled hole is subsequently followed by a tensile force to reinforce the structure [10]. This anchor may be put into practically any kind of soil to generate a huge concentrated force, although in certain foundations the force that operates is a tensile force rather than a compressive force. Because the soil cannot bear the draw, an armature system is employed on the ground where the pulling force or pulling force is kept by the armature which is planted deep into the ground [11]. According to the definition above, the anchor is a component of the structure that works to transfer tensile tension from the main structure to the soil layers around the anchor [12]. The shear strength of the soil resists this tensile stress. Hence, the higher the shear strength, the larger the anchor carrying capacity. Coyne used ground anchors for the first time in the mid-1930s to fortify the Cheurfas dam in Algeria. The benefit of employing anchors is that its implementation does not require the use of a specific field [13].

Several experiments, such as the behavior of spherical anchor plates with uplift tests on cohesive soils [14], the anchoring ability of star-shaped plates on compacted cohesive soils [15], and other similar experiments, have been conducted. Several more study findings seek to comprehend the behaviour of anchors in cohesive and non-cohesive soils under dynamic and static pressures [16]. In addition to theoretical and experimental research, the majority of which focuses on the failure behaviour and tensile capacity of anchors tested on non-cohesive soils, just a few have looked at the issue of cohesive soils [17]. Previous studies attempted to predict the behaviour of anchors in the field by simulating laboratory test models and using numerical algorithms or theoretical formulations [18]. During field installation, the researchers encountered issues with the usage of huge plate anchors [19]. This is particularly true if the anchors are put in water regions on saturated cohesive soils, since they must first be dug to the necessary depth, then the anchors installed, and then backfilled [18]. One of the previous researchers suggested that more research be done on the development of the shape and model of the anchor that can be expanded (spread) when the anchor has been planted at a specified depth position and is easy to apply in the field and has ease of installation while still having a large enough tensile capacity, particularly for the use of anchors on cohesive soils with a large thickness [20]. It is feasible to innovate by utilising anchor pieces with varying variations in size or area, particularly when using anchors on cohesive soils or soft soils [21].

A folding type soil anchor model made up of four (four) leaves is the most recent invention created in this research. This folding ground anchor is a variant of the star-shaped plate anchor. The use of folding type anchors on cohesive soil at a pre-set depth with the expectation that the anchor element would bloom or expand on its own as the anchor is gently pushed to enhance shear resistance until the manometer reading (dial gauge) does not occur again. The tensile capacity model of the folding type anchor will be tested on cohesive soil (soft soil) with modifications in the size and depth of the anchor as the first stage of development. In order to achieve the maximum tensile force, the pull-up capability of the anchor must be examined in order to determine the maximum anchor tensile force to be planned.

No one has ever employed folding anchors in their studies. The previous researchers' technique, particularly the star anchor plate [1], is used in this study's analytical approach. The sole difference is that the plate anchor work system is enormous and stiff, while the folding anchor is flexible and may be placed into the earth completely [22]. The anchor is withdrawn after reaching the set depth, and the anchor may bloom or open after reading the dial gauge. Tensile strength does not grow further. The anchor work is considered after the anchor has been entirely opened. The analytical method is thought to be the same as the enormous stellar plate anchor [23].

## 3. Materials and Methods

There are many ways of determining the tensile capacity of anchor plates, including theoretical approaches, computational approaches, model tests, and full-scale field tests. Although, in general, laboratory model experiments

must be supplemented by full-scale field testing [15]. This study employs two approaches: experimental research by evaluating the model in the laboratory and full-scale field testing. The first stage is to assess the soil's physical and mechanical properties to ensure that it fits the necessary soil standards in the form of cohesive soil. Furthermore, the anchor model is tested so that the limit tensile capacity and soil failure models may be determined. Following laboratory testing, full-scale field testing should be performed to compare the findings of the laboratory model test. Each test site employs one of three anchor models (Figures 3 and 4).

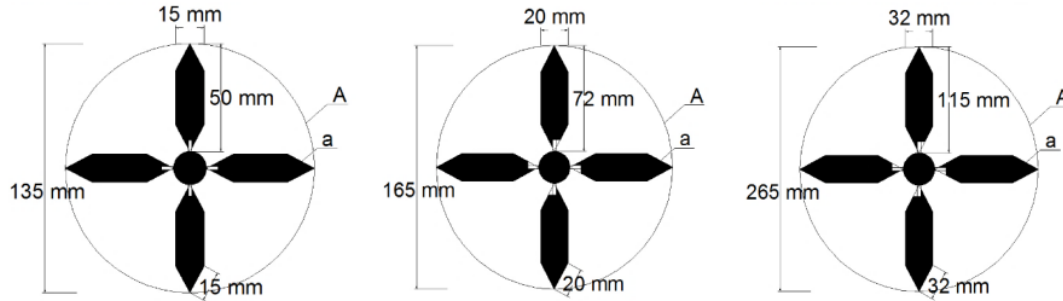

Figure 1. Model of 4-leaf folding anchors for Field Test

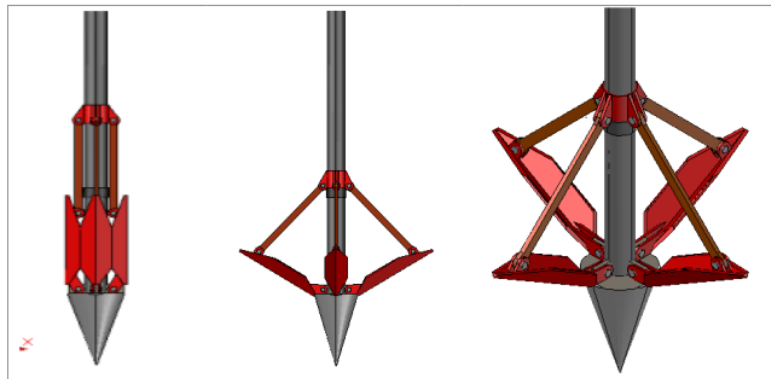

Figure 2. Folding Anchor 3D Model

Each compacted and levelled layer of soil is then painted or colored above the surface as a boundary layer in order to monitor the soil collapse model once the pulling test is done. The foldable anchor is installed by connecting rods with a diameter of 22 mm. After inserting the soil sample into the test column, which had been statically compacted as high as 120 cm, hydraulic jacks were used to insert/pierce the anchors into the soil at each design depth of 30 cm, 60 cm, and 90 cm. The load is then constantly drawn until the maximum pulling force is reached, which is shown by the lack of a rise in the tensile load. A tensile force vs. deformation curve or anchor displacement may be recorded during the anchor pulling testing procedure. The maximum tensile bearing capacity of the folding anchor model may be observed from the tensile test results. To identify the model of soil failure, a dial gauge will be mounted on the ground surface surrounding the anchor model to measure the deformation of the soil that happens during loading.

21 **4. Results and Discussions**

This study covers the analysis of the physical and mechanical properties of the soil employed as a medium in this experiment, including sieve and hydrometer analysis tests, moisture content tests, soil specific gravity tests (GS), metric weight tests, and Atterberg limit tests. The mechanical characteristics are tested, including soil compaction (proctor compaction), direct shear test, unconfined compression test (UCT), and hand penetrometer (QC), and the soil test results are acquired, as summarised in Table 1.

7 **Table 1. Soil Investigation Result**

No.	Types of Laboratory Testing	Unit	Results
A.	<i>Index physical properties</i>		
1	Moisture Content	%	54.00
2	Specific Gravity (GS)		2.73

3	Sieve analysis (sieve No. 200)	%	87.4
<i>Atterberg Limits:</i>			
	Plastic Limit, wp (%)	%	19.60
	Liquid Limit, wL (%)	%	54.50
4	Plastic Index, Ip=wL-Ip	%	34.90
	Shrinkage Limit	%	21.383
<b>B. Mechanical properties</b>			
1	Unconfined Compression Test (UCT) = qu	ton /ft <sup>2</sup>	0.36
		kg/cm <sup>2</sup>	0.033
2	Direct Shear Test (φ)	degree	16 <sup>o</sup> 46'
3	C (soil cohesion)	kg/cm <sup>2</sup>	1.0014
4	Compaction (Y <sub>dmax</sub> )	gr/cm <sup>3</sup>	1.08
5	Compaction (Y <sub>wet</sub> )	gr/cm <sup>3</sup>	1.66

The laboratory density parameters obtained from the standard compaction test (Standard Proctor Test) were the maximum moisture content of  $W_{opt} = 38\%$  and the maximum dry weight of  $1.26 \text{ gr/cm}^3$ . The soil moisture content to be compacted was  $w = 81.87\%$  percent with a dry volume weight of  $d = 0.25 \text{ gr/cm}^3$  based on the density of the soil in the test container/test column. The value of the Relative Density (R) of the soil of the test medium is determined from the results of the laboratory density test and the field density test, namely the ratio between the dry density of the field and the dry density of the laboratory = dry field/dry lab.

$$R = (0.25/1.26) \times 100\% = 19.84\% \tag{1}$$

The unconfined compression test (UCT) findings show an average value of  $q_u = 0.226 \text{ kg/cm}^2 = 0.15 \text{ ton/ft}^2$ , indicating that the soil has a fairly soft consistency. The Hand Penetrometer (HP) test is used to determine the bearing capacity of the soil, which is similar to the cone penetrometer test. The average  $q_c = 3,731 \text{ kg/cm}^2$  was obtained from the hand penetrometer testing. The earth is of very soft consistency.

Figure 3 depicts the relationship curve of the anchor displacement with the tensile load for various anchor types and depths. The behaviour of the tensile load connection with the displacement interval has a very substantial rise in tensile load in the laboratory tensile test at a depth of 30 cm by 60 cm with an anchor displacement interval of every 20 mm. While the behaviour of the tensile load relationship is comparable for depths of 60 cm and 90 cm, the maximum tensile load is not significantly different. Similarly, the behaviour of the tensile load relationship with the anchor displacement interval has a very substantial rise in tensile load in the full-scale tensile test in the field at a depth of 100 cm by 200 cm with an anchor displacement interval of every 10 cm. Meanwhile, at depths of 200 cm and 300 cm, the tensile load relationship behaves similarly, and the maximum tensile load is not significantly different. We can see the curves for all anchor types where the curve is steep at first to a specific amount of load rise until there is no more load growth. The maximum pull-up capacity has been attained in this circumstance. Then it seems that there is no increase in load until a specific anchor displacement occurs. This demonstrates that the anchor insertion/puncture depth has a critical limit beyond which increasing the depth will no longer improve the maximum pull-up capability.

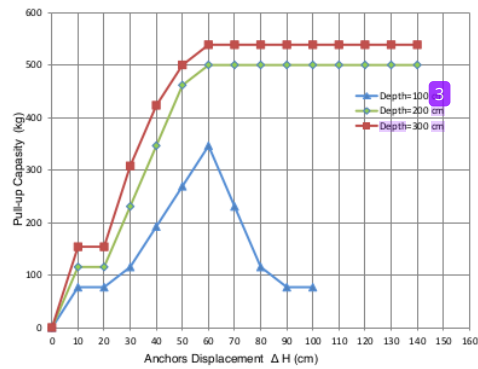
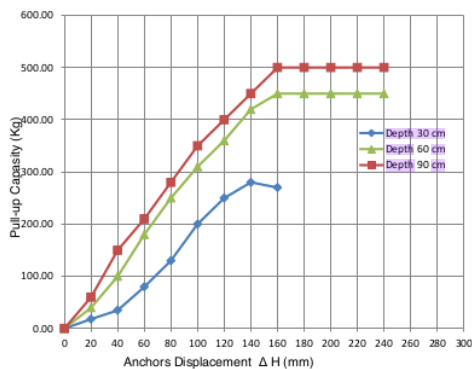

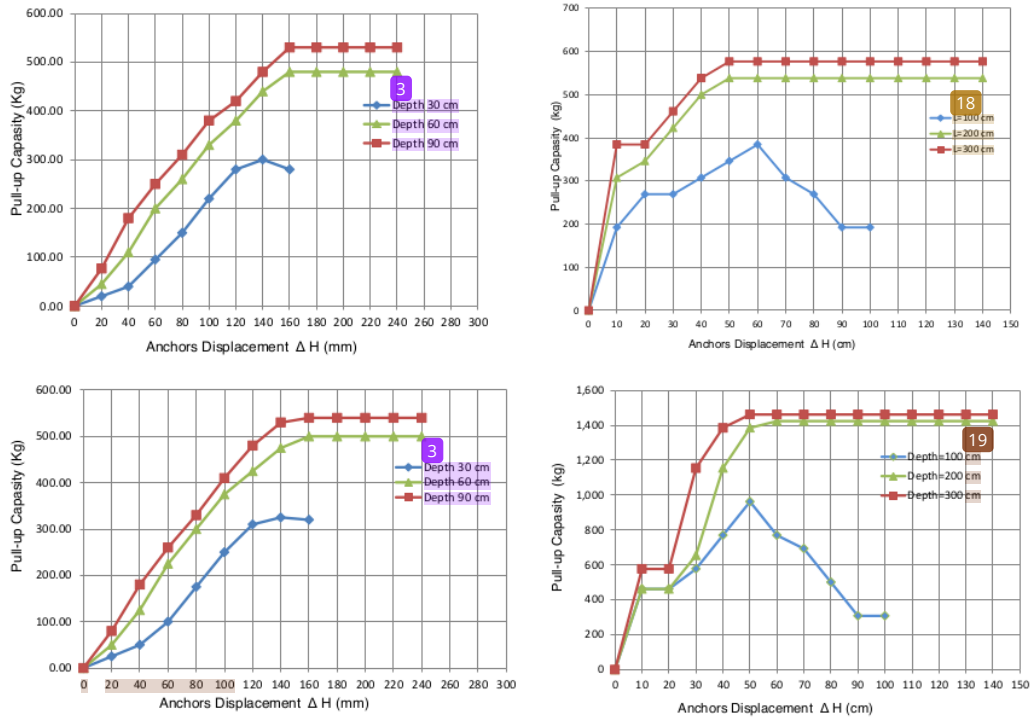
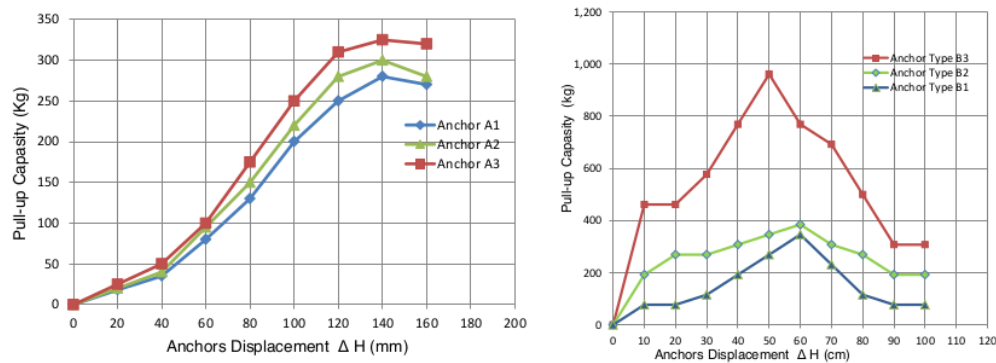

Figure 3. Anchor pull-up capability and depth relationship (Left=Laboratory Test, Right=Field Test)

According to Figure 4, the change in area increase for each anchor type to each depth resulted in a considerable rise in pull-up load. The maximum pull-up load produced increases with the size of the anchoring area. When pushed with an anchor displacement of 20 mm at intervals at a depth of 30 cm, all variants of the anchor model may be observed. The displacement of the anchor to a location of 140 mm has experienced the maximum pulling load and immediately experienced a drop in the pull-up load for the three distinct variants of the anchor. The soil has failed under these conditions. This signifies that the soil above the anchor is no longer capable of supporting the pulling tension that has nearly reached the soil's surface. The pull-up load value on the towing machine's manometer (dial gauge) is recorded for every 20 mm of anchor displacement. The behaviour of the pulling load relationship with an anchor displacement interval of every 20 mm is identical for the three variants of the various anchor types at depths of 60 cm and 90 cm. This implies that the folding type anchor model does not need to be very complex. When the anchor is gently withdrawn, the pulling load increases until there is no longer a rise in the pull-up load, at which point the anchor withdrawal is halted. The maximum pull-up capacity has been obtained at anchor displacements of up to 160 mm. This means that once the anchor was initially pulled, the element or leaf of the anchor gradually opened, followed by a little rise in load until there was no further increase in load. The anchor element is completely opened at that moment, and the anchor withdrawal is halted. The maximum pull-up capacity has been attained in these circumstances.



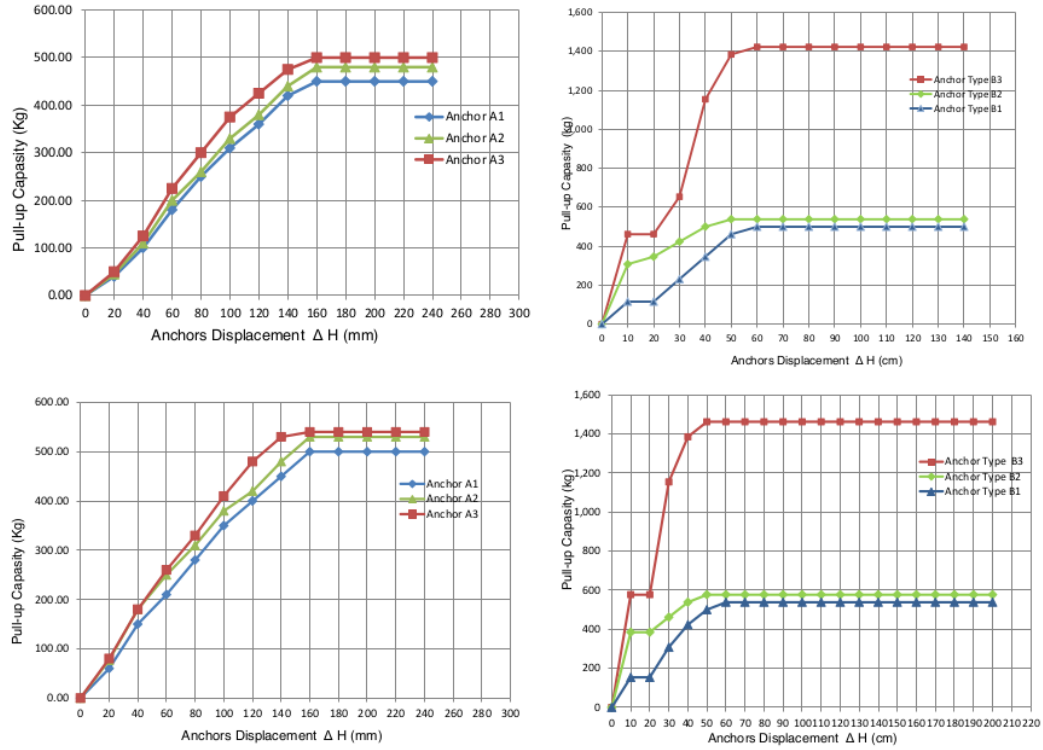
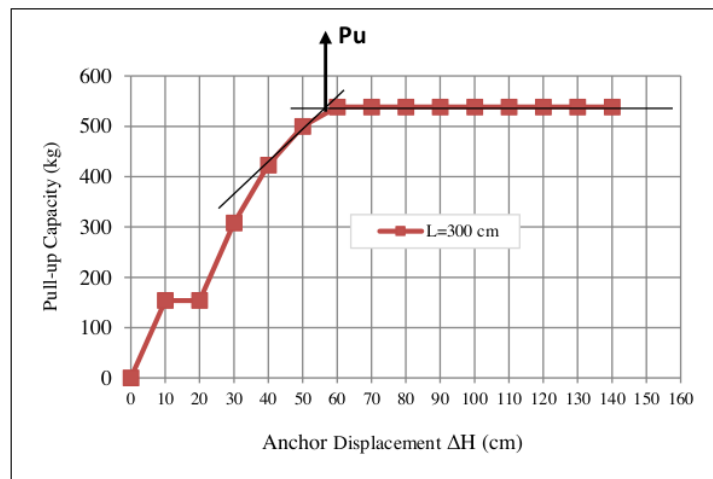

Figure 4. Anchor pull-up capability and depth relationship against varied anchor types (Left=Laboratory Test, Right=Field Test)

Anchoring at a depth of 300 cm, maximum extension was achieved at a displacement of 600 mm, and a maximum pull-up capacity of 539 kg was achieved. At a depth of 200 cm, full extension of the anchor occurs at a displacement of 600 mm, and the pull-up capacity reaches a maximum  $P_u$  of 500 kg (Figure 5).



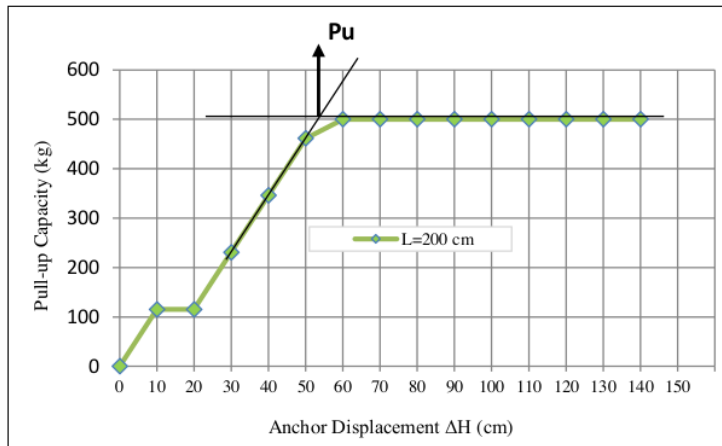

Figure 4. Maximum pull-up capacity curve with type B1 anchor displacement to a depth of 300 cm, and 200 cm

When the anchor was pulled at a depth of 100 cm (Figure 6), it had completely expanded at an anchor displacement of 60 mm and had a maximum pull-up capacity of 346 kg, but since it was so near to the surface, the bearing capacity of the soil above the anchor had failed.

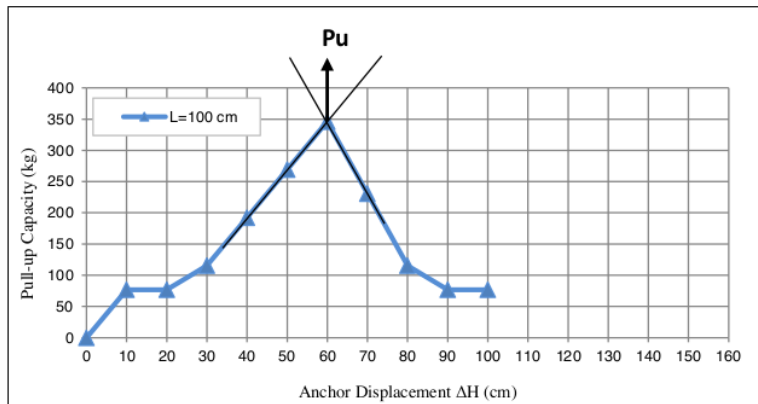

Figure 5. Maximum pull-up capacity and displacement relation of B1 anchor to a depth of 100 cm

Table 2. Recapitulation of maximum pull-up capacity (Pu) in Laboratory Tests

No.	Anchor Model	Diameter (cm)	A=Area of the Anchor Circle (cm <sup>2</sup> )	a=Effective Area of the Anchors (cm <sup>2</sup> )	Pu (kg)		
					Depth 30 cm	Depth 60 cm	Depth 90 cm
1	A1	13.50	143.07	30.00	280	450	500
2	A2	16.50	213.72	57.60	300	480	530
3	A3	26.50	551.27	147.20	325	500	540

Table 3. Recapitulation of maximum pull-up capacity (Pu) in Full-Scale Field Tests

No.	Anchor Model	Diameter (cm)	A=Area of the Anchor Circle (cm <sup>2</sup> )	a=Effective Area of the Anchors (cm <sup>2</sup> )	Pu (kg)		
					Depth 100 cm	Depth 200 cm	Depth 300 cm
1	B1	16.50	213.72	57.60	346	500	539
2	B2	26.50	551.27	147.20	385	539	577
3	B3	46.50	1,697.37	600.00	962	1,423	1,462

Figure 7 which displays the histogram of the relationship between the maximum pull-up capacity of each variation of the anchor model as follows, illustrates the differences in the results of determining the maximum pull-up capacity for all variations of the anchor model that have been tested in the laboratory with variations in depth (Table 4).

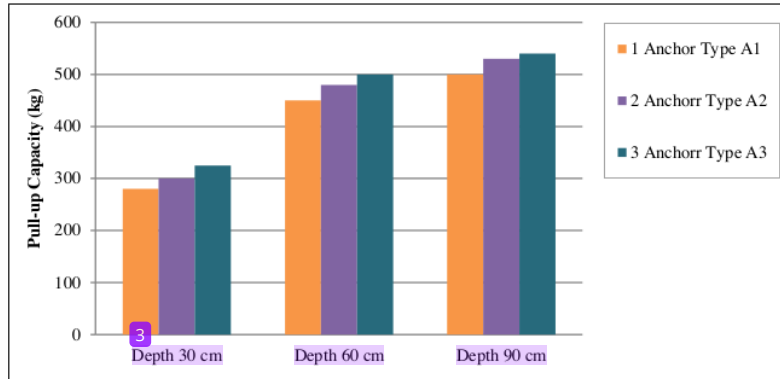

Figure 6. Relation of maximum pull-up capacity (Pu) for varied anchor models and depth

Table 4. Decrease in effective anchor area and pull-up capacity

Anchor Type	A1	A2	A3
Area (mm) <sup>2</sup>	3000	5760	14720
Area Change (%)	0	92.00	390.67
Pull-up Capacity / Percentage Ultimate Pull-up Capacity Change	depth 30	280 / 7.14	325 / 16.07
	depth 60	450 / 6.67	500 / 11.11
	depth 90	500 / 6.00	540 / 8.00

By using the A1 anchor model as a reference, the variations in pull-up capability for each model of anchor type at various depths are calculated as follows (see Figures 8 and 9):

- Pull-up capacity rose from A1 to A2 by 7.14 percent and from A1 to A3 by 16.07 percent at a depth of 30 cm.
- Pull-up capacity rose from A1 to A2 by 6.67 percent and from A1 to A3 by 11.11 percent at a depth of 60 cm.
- Pull-up capacity changes from A1 to A2 at a depth of 90 cm by 6.0 percent and from A1 to A3 by 8.0 percent.

Additionally, it is observed that the pull-up capacity varies depending on the depth for each effective region of the anchor type model. The percentage change in pull-up capacity is calculated using the A1 anchor model as a reference and is as follows:

- In the A2 type anchor model, the change in area from A1 to A2 is 92.00 percent, and the percentage of tensile stress at each level decreases starting at 30 cm by 7.14 percent, then by 6.67 percent at 60 cm, and by 6.00 percent at 90 cm.
- In the A3 type anchor model, the area change from A1 to A3 is 390.67 percent, and the percentage of tensile stress decreases at each depth, starting at 30 cm by 16.07 percent, continuing to 11.11 percent at 60 cm, and ending at 90 cm by 8.00 percent.

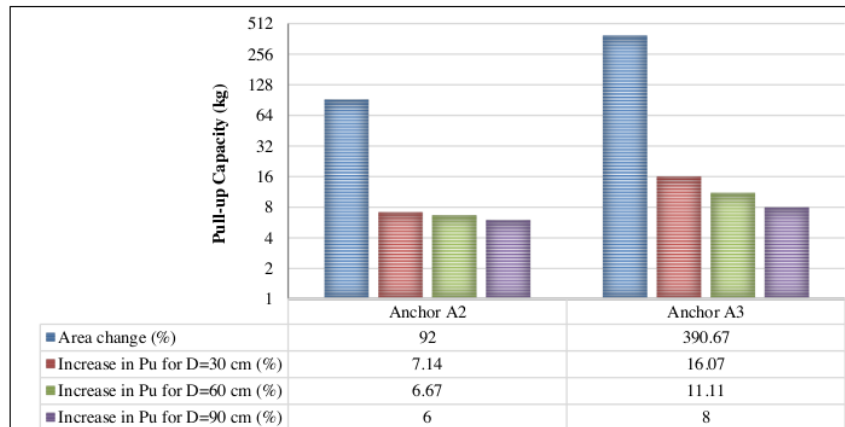
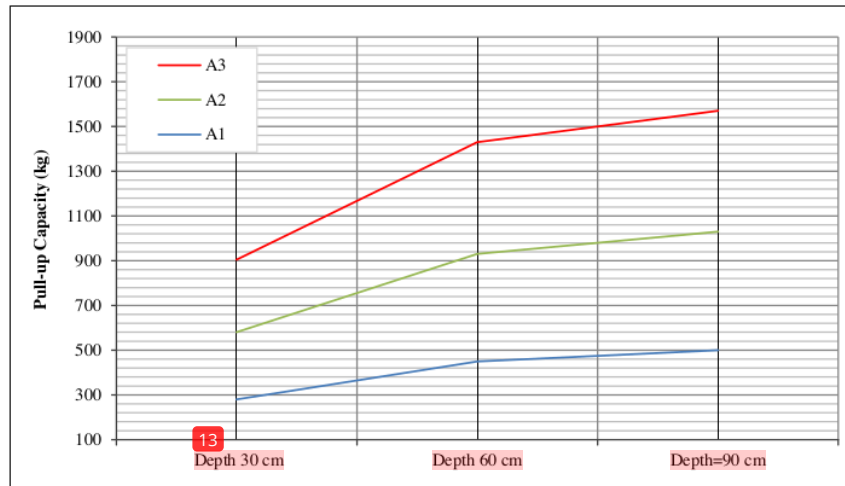

Figure 7. Decrease in effective anchor area and pull-up capacity of Anchor A2 and A3



**Figure 8. Maximum pull-up capacity against intake depth**

Tensile load changes with improvements in area for each anchor model at each depth, although there is a percentage drop in tensile load with each rise in depth for each anchor model. The tensile load percentage decreases with increasing anchor depth. In light of this, it can be said that this folding anchor does not need a deep insertion or stab before being pulled. Prior to choosing the depth, the maximum number of pull-ups must be anticipated or determined.

## 5. Conclusion

The maximum pull-up capacity for the variation of the anchor model's area to depth reveals that the change in the area for each anchor model to each depth experienced a significant rise in pull-up load. The maximum pull-up load produced increases with the size of the anchoring area. The pull-up load did not significantly rise as the change in depth did for each alteration of the anchor. This suggests that a folding type anchor model does not need a deep design. The research of how the depth of insertion/piercing of the folding type of soil anchor affected the maximum pull-up capacity for each variation in dimensions (area) found a critical limit beyond which an increase in depth would no longer automatically enhance the capacity. The maximum pull-up test results were comparable when the pull-up capability of the results of laboratory experimental tests with those of full-scale field testing were compared. It identified a way that uses appropriate equipment in the field without excavating or drilling the ground, is extremely simple to install, and yet has a lot of pull-up capability.

## 6. Declarations

### 6.1. Author Contributions

Conceptualization, M.I.M.; methodology, M.I.M.; software, M.I.M.; validation, A.R.D., T.H., and A.B.M.; formal analysis, M.I.M.; investigation, M.I.M.; resources, M.I.M.; data curation, M.I.M.; writing—original draft preparation, M.I.M.; writing—review and editing, M.I.M.; visualization, M.I.M.; supervision, A.R.D., T.H., and A.B.M.; project administration, M.I.M.; funding acquisition, M.I.M. All authors have read and agreed to the published version of the manuscript.

### 6.2. Data Availability Statement

The data presented in this study are available in the article.

### 6.3. Funding

The authors received no financial support for the research, authorship, and/or publication of this article.

### 6.4. Acknowledgements

The authors would like to deliver the greatest appreciation to Civil Engineering Department of Universitas Hasanuddin and Geo-Environmental and Soil Mechanics Laboratory for supporting the technical aspects of the investigation.

## 6.5. Conflicts of Interest

The authors declare no conflict of interest.

## 7. References

- [1] Djamaluddin, R., Samang, L., Imran, A. M., & Muhiddin, A. B. (2015). Numerical Study of Star Anchor Plate Embedded in Cohesive Soil. *Int. Journal of Engineering Research and Application*, 5(7), 36–40.
- [2] Tilak, B. V., & Samadhiya, N. K. (2021). Pullout capacity of multi-plate horizontal anchors in sand: an experimental study. *Acta Geotechnica*, 16(9), 2851–2875. doi:10.1007/s11440-021-01173-1.
- [3] Jadid, R., Shahriar, A. R., Rahman, M. R., & Intiaz, T. (2019). Evaluation of Theoretical Models to Predict the Pullout Capacity of a Vertical Anchor Embedded in Cohesionless Soil. *Geotechnical and Geological Engineering*, 37(5), 3567–3586. doi:10.1007/s10706-019-00870-9.
- [4] Liang, W., Zhao, J., Soga, K. (2021). Multi-scale Modeling of Anchor Pull-Out in Sand. *Challenges and Innovations in Geomechanics, IACMAG 2021, Lecture Notes in Civil Engineering*, 125. Springer, Cham, Switzerland. doi:10.1007/978-3-030-64514-4\_84.
- [5] Yi, J. T., Fu, Y., Liu, C. F., Zhang, Y. H., Li, Y. P., & Zhang, X. Y. (2020). Pull-out capacity of an inclined embedded torpedo anchor subjected to combined vertical and horizontal loading. *Computers and Geotechnics*, 121. doi:10.1016/j.compgeo.2020.103478.
- [6] Giampa, J. R., Bradshaw, A. S., Gerkus, H., Gilbert, R. B., Gavin, K. G., & Sivakumar, V. (2019). The effect of shape on the pull-out capacity of shallow plate anchors in sand. *Geotechnique*, 69(4), 355–363. doi:10.1680/jgeot.17.P.269.
- [7] Pandey, A., & Chauhan, V. B. (2020). Evaluation of Pull-Out Capacity of Helical Anchors in Clay Using Finite Element Analysis. *Geo-Congress 2020*. doi:10.1061/9780784482803.007.
- [8] Liu, J., Tan, M., & Hu, Y. (2018). New analytical formulas to estimate the pullout capacity factor for rectangular plate anchors in NC clay. *Applied Ocean Research*, 75, 234–247. doi:10.1016/j.apor.2018.04.002.
- [9] Yang, Y., Liu, H., & Zhao, Y. (2021). The pullout capacity of OMNI-Max anchors in clay. *Ocean Engineering*, 230. doi:10.1016/j.oceaneng.2021.109063.
- [10] Dapuetto, G., Massa, F., Pergent-Martini, C., Povero, P., Rigo, I., Vassallo, P., Venturini, S., & Paoli, C. (2022). Sustainable management accounting model of recreational boating anchoring in Marine Protected Areas. *Journal of Cleaner Production*, 342, 130905. doi:10.1016/j.jclepro.2022.130905.
- [11] Ganesh, R., & Khuntia, S. (2018). Estimation of Pullout Capacity of Vertical Plate Anchors in Cohesionless Soil Using MARS. *Geotechnical and Geological Engineering*, 36(1), 223–233. doi:10.1007/s10706-017-0319-4.
- [12] Hu, S., Zhao, L., Tan, Y., Luo, Y., & Zeng, Z. (2022). Three-dimensional upper-bound limit analysis of ultimate pullout capacity of anchor plates using variation method. *International Journal for Numerical and Analytical Methods in Geomechanics*, 46(7), 1356–1379. doi:10.1002/nag.3349.
- [13] Ghosh, P., Samal, S. (2019). Ultimate Pullout Capacity of Isolated Helical Anchor Using Finite Element Analysis. *Soil Dynamics and Earthquake Geotechnical Engineering, Lecture Notes in Civil Engineering*, 15, Springer, Singapore. doi:10.1007/978-981-13-0562-7\_26.
- [14] Bhattacharya, P. (2017). Pullout capacity of shallow inclined anchor in anisotropic and nonhomogeneous undrained clay. *Geomechanics and Engineering*, 13(5), 825–844. doi:10.12989/gae.2017.13.5.825.
- [15] Liu, X., Wang, J., Huang, J., & Jiang, H. (2017). Full-scale pullout tests and analyses of ground anchors in rocks under ultimate load conditions. *Engineering Geology*, 228, 1–10. doi:10.1016/j.enggeo.2017.07.004.
- [16] Peng, J., Liu, H., Zhao, Y., & Liang, K. (2020). Failure mode and pullout capacity of anchor piles in soils with cohesive and cohesionless properties. *Marine Georesources and Geotechnology*, 38(9), 1056–1069. doi:10.1080/1064119X.2019.1649332.
- [17] Giresini, L., Puppio, M. L., & Taddei, F. (2020). Experimental pull-out tests and design indications for strength anchors installed in masonry walls. *Materials and Structures/Materiaux et Constructions*, 53(4). doi:10.1617/s11527-020-01536-2.
- [18] Sharma, A., Alzaylaie, M., Vandanapu, R., & Khalaf, K. (2021). Numerical and Analytical Studies of 3D Effects on Pullout Capacity of Anchor Blocks in Granular Compacted Fill. *International Journal of Geosynthetics and Ground Engineering*, 7(1). doi:10.1007/s40891-021-00259-w.
- [19] Koh, K. X., Hossain, M. S., & Kim, Y. (2017). Installation and Monotonic Pullout of a Suction Caisson Anchor in Calcareous Silt. *Journal of Geotechnical and Geoenvironmental Engineering*, 143(2). doi:10.1061/(asce)gt.1943-5606.0001604.

- [20] Singh, V., Maitra, S., & Chatterjee, S. (2017). Generalized Design Approach for Inclined Strip Anchors in Clay. *International Journal of Geomechanics*, 17(6). doi:10.1061/(asce)gm.1943-5622.0000849.
- [21] Cheng, P., Yi, J. T., Liu, F., & Dong, J. J. (2020). Characterization of model uncertainty for the vertical pullout capacity of helical anchors in cohesive soils. *Journal of Marine Science and Engineering*, 8(10). doi:10.3390/JMSE8100738.
- [22] Du, Y., Liu, F., Zhou, M., & He, J. (2022). Multi-scale pullout behaviour of strip anchor plates embedded in marine hydrate bearing sediments. *Computers and Geotechnics*, 141. doi:10.1016/j.compgeo.2021.104472.
- [23] Zhao, L. Heng, Tan, Y. Gao, Nie, Z. Hong, Yang, X. Ping, & Hu, S. Hong. (2018). Variation analysis of ultimate pullout capacity of shallow horizontal strip anchor plate with 2-layer overlying soil based on nonlinear M-C failure criterion. *Journal of Central South University*, 25(11), 2802–2818. doi:10.1007/s11771-018-3954-x.

ORIGINALITY REPORT

---

10%

SIMILARITY INDEX

8%

INTERNET SOURCES

6%

PUBLICATIONS

5%

STUDENT PAPERS

---

PRIMARY SOURCES

---

1	Submitted to Universitas Muhammadiyah Sinjai Student Paper	3%
2	ijournalse.org Internet Source	1%
3	mountainscholar.org Internet Source	1%
4	Izabela Miturska, Anna Rudawska, Miroslav Müller, Petr Valášek. "The Influence of Modification with Natural Fillers on the Mechanical Properties of Epoxy Adhesive Compositions after Storage Time", Materials, 2020 Publication	1%
5	Toshiaki Mochizuki, Yutaka Kojima, Yuko Nishiwaki, Tetsuya Harakuni, Ichiro Masai. "Endocytic trafficking factor VPS45 is essential for spatial regulation of lens fiber differentiation in zebrafish", Development, 2018 Publication	<1%

---

6

[pureadmin.qub.ac.uk](http://pureadmin.qub.ac.uk)

Internet Source

&lt;1 %

7

Arifin Beddu, Lawalenna Samang, Tri Harianto, Achmad Bakri Muhiddin.

"Interpretation of CBR Test Results Based on the Rapid Impact Compaction Electro-Mechanic System Model", MATEC Web of Conferences, 2018

Publication

&lt;1 %

8

"Ground Characterization and Foundations", Springer Science and Business Media LLC, 2022

Publication

&lt;1 %

9

[www.aimspress.com](http://www.aimspress.com)

Internet Source

&lt;1 %

10

"Construction in Geotechnical Engineering", Springer Science and Business Media LLC, 2020

Publication

&lt;1 %

11

[www.researchgate.net](http://www.researchgate.net)

Internet Source

&lt;1 %

12

Anna Krzyszowska-Waitkus. "A field lysimeter study to evaluate herbicide transport in a wyoming irrigated pasture", Communications in Soil Science and Plant Analysis, 01/1999

Publication

&lt;1 %

[cdn.forestresearch.gov.uk](http://cdn.forestresearch.gov.uk)

13	Internet Source	<1 %
14	<a href="https://hdl.handle.net">hdl.handle.net</a> Internet Source	<1 %
15	"Local Site Effects and Ground Failures", Springer Science and Business Media LLC, 2021 Publication	<1 %
16	Yancheng Yang, Haixiao Liu, Yanbing Zhao. "The pullout capacity of OMNI-Max anchors in clay", Ocean Engineering, 2021 Publication	<1 %
17	<a href="https://itjfs.com">itjfs.com</a> Internet Source	<1 %
18	<a href="https://kon.webtorg.ru">kon.webtorg.ru</a> Internet Source	<1 %
19	<a href="https://serval.unil.ch">serval.unil.ch</a> Internet Source	<1 %
20	<a href="https://www.repositorio.ufop.br">www.repositorio.ufop.br</a> Internet Source	<1 %
21	"Recent Developments in Sustainable Infrastructure (ICRDSI-2020)—GEO-TRA-ENV- WRM", Springer Science and Business Media LLC, 2022 Publication	<1 %

22 Lee, K.S.. "Analysis of water movement through an unsaturated soil zone in Jeju Island, Korea using stable oxygen and hydrogen isotopes", Journal of Hydrology, 20071030  
Publication <1 %

---

23 Lian-heng Zhao, Yi-gao Tan, Shi-hong Hu, Dong-ping Deng, Xin-ping Yang. "非线性Mohr-Coulomb 破坏准则下浅埋三维圆形锚板极限抗拔力上限分析", Journal of Central South University, 2018  
Publication <1 %

---

24 [agrogeoambiental.ifsuldeminas.edu.br](http://agrogeoambiental.ifsuldeminas.edu.br)  
Internet Source <1 %

---

25 [civillabbd.blogspot.com](http://civillabbd.blogspot.com)  
Internet Source <1 %

---

26 [doaj.org](http://doaj.org)  
Internet Source <1 %

---

27 [www.nrcresearchpress.com](http://www.nrcresearchpress.com)  
Internet Source <1 %

---

Exclude quotes On

Exclude matches < 5 words

Exclude bibliography On